

Diffuse mode sensor

OBD200-18GM60-E4-IR-1C



- Strong metallic housing in cylindrical shape M18 x 1
- Operating distance adjustable
- Not sensitive to ambient light
- Degree of protection IP67
- High operating distance



Function

The optical sensors of this series have an M18 threaded housing that is optionally available in plastic or metal. The sensors are robust and versatile. Focusing on the essential requirements simplifies selection and commissioning, saving time and costs.

Dimensions

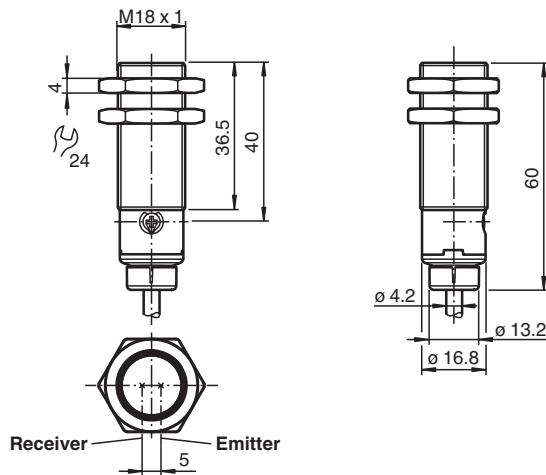

Technical Data

General specifications	
Detection range	0 ... 200 mm
Detection range min.	0 ... 30 mm
Detection range max.	0 ... 200 mm
Adjustment range	30 ... 200 mm
Reference target	standard white 200 mm X 200 mm
Light source	IRED
Light type	infrared
Diameter of the light spot	approx. 22 mm at 200 mm
Opening angle	approx. 2.6 °
Optical face	frontal
Ambient light limit	EN 60947-5-2 10000 Lux

Release date: 2022-08-29 Date of issue: 2022-08-29 Filename: 70113328-100149_eng.pdf

Refer to "General Notes Relating to Pepperl+Fuchs Product Information".

Pepperl+Fuchs Group
www.pepperl-fuchs.com

USA: +1 330 486 0001
fa-info@us.pepperl-fuchs.com

Germany: +49 621 776 1111
fa-info@de.pepperl-fuchs.com

Singapore: +65 6779 9091
fa-info@sg.pepperl-fuchs.com

PF PEPPERL+FUCHS

Technical Data

Hysteresis	H	< 15 %
Functional safety related parameters		
MTTF _d		854 a
Mission Time (T _M)		20 a
Diagnostic Coverage (DC)		0 %
Indicators/operating means		
Operation indicator		LED green: on - power on flashing (4 Hz) - short circuit
Function indicator		LED yellow: permanently lit - output active permanently off - output inactive
Control elements		sensitivity adjustment
Control elements		light/dark on electrically switchable
Electrical specifications		
Operating voltage	U _B	10 ... 30 V DC
Ripple		max. 10 %
No-load supply current	I ₀	< 25 mA
Protection class		III
Output		
Switching type		The switching type of the sensor is adjustable. The default setting is: Q - Pin4: NPN output / light-on L/D-On - WH: Low-active input
Signal output		1 NPN output, short-circuit protected, reverse polarity protected, open collector
Switching voltage		max. 30 V DC
Switching current		max. 100 mA , resistive load
Voltage drop	U _d	≤ 2 V DC
Switching frequency	f	500 Hz
Response time		≤ 1 ms
Conformity		
Product standard		EN 60947-5-2
Approvals and certificates		
UL approval		E87056 , cULus Listed , class 2 power supply , type rating 1
Ambient conditions		
Ambient temperature		-40 ... 60 °C (-40 ... 140 °F)
Storage temperature		-40 ... 70 °C (-40 ... 158 °F)
Mechanical specifications		
Degree of protection		IP67
Connection		2 m fixed cable
Material		
Housing		brass, nickel-plated
Optical face		PMMA
Cable		PVC
Mass		approx. 70 g

Connection

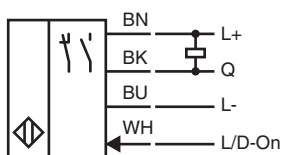

Indication

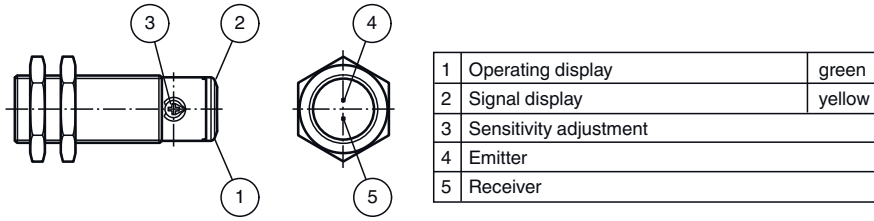



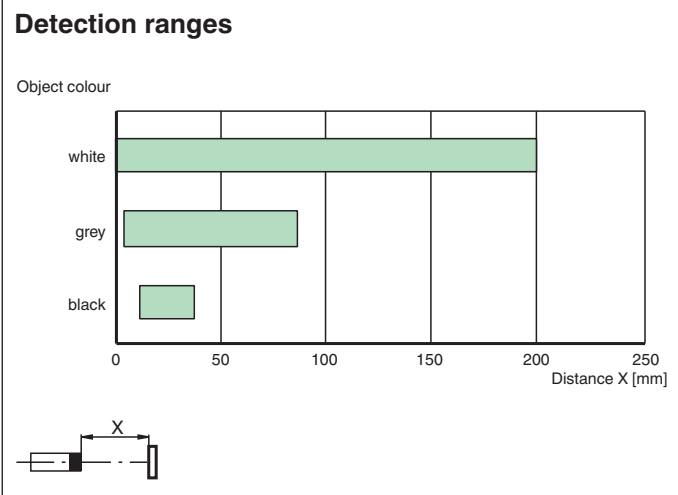
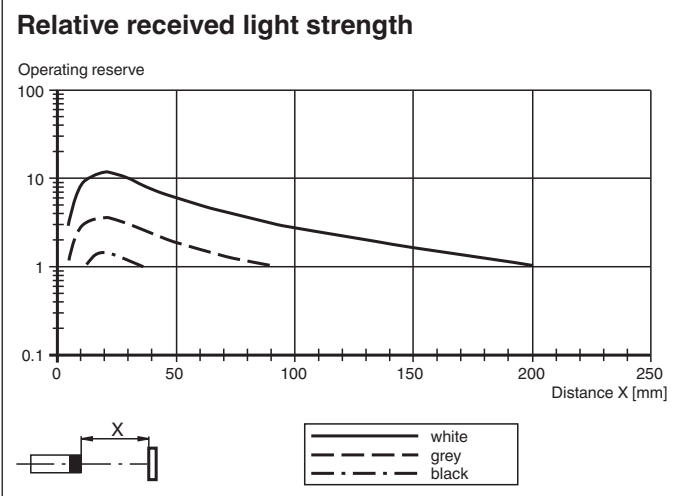
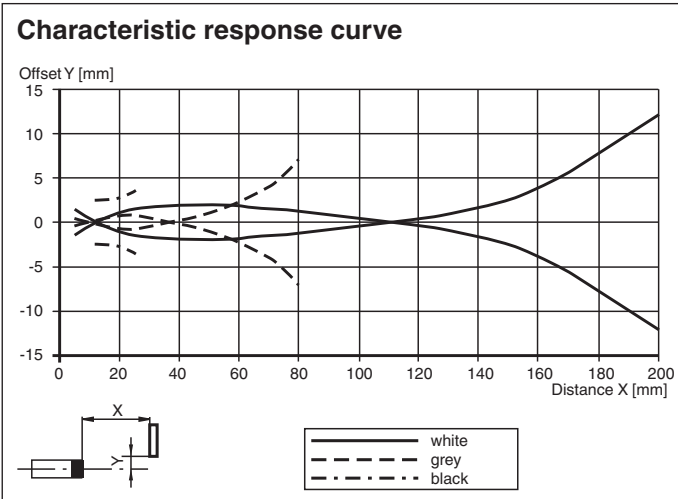

Characteristic Curve



Release date: 2022-08-29 Date of issue: 2022-08-29 Filename: 70113328-100149_eng.pdf

Refer to "General Notes Relating to Pepperl+Fuchs Product Information".

Accessories

	BF 18	Mounting flange, 18 mm
	CPZ18B03	Mounting Bracket with swivel nut
	BF 18-F	Plastic mounting adapter, 18 mm
	BF 5-30	Universal mounting bracket for cylindrical sensors with a diameter of 5 ... 30 mm